

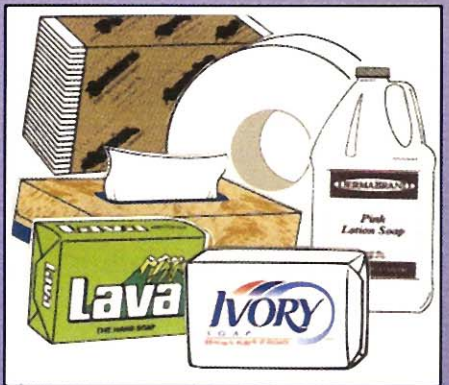

ENTERPRISES, INC.

PACKAGING LIGHTING JANITORIAL RACKING

WE HAVE THE PRODUCTS YOU'RE LOOKING FOR!!!

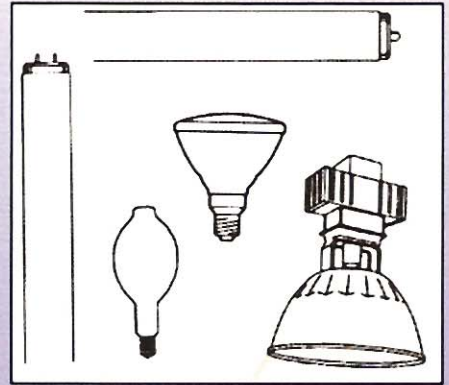
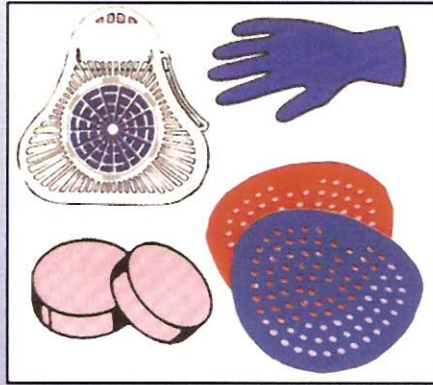
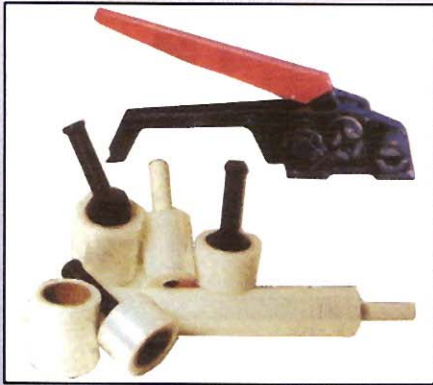

132 W. DEVON AVE. BENSENVILLE, IL. 60106
CALL (630) 766-5400 OR FAX (630) 766-5593
www.CogsEnterprises.com

PACKAGING SUPPLIES

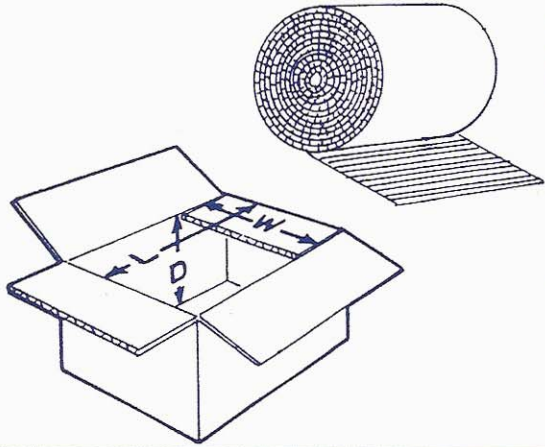

AIRFREIGHT CONTAINERS
BIN BOXES
CORRUGATED
 BOXES ROLLS
 INSERTS SHEETS
 MAILERS TUBES
 PADS VIDEO MAILERS
CHIP BOARD
 BOXES
 POLYCOATED PADS
 STANDARD PADS
 STAY FLAT MAILERS

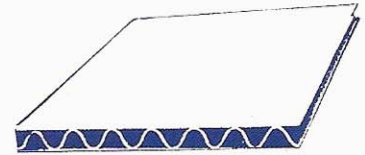
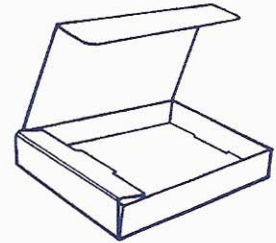

INTERIOR PACKING

KRAFT PAPER



BUBBLEWRAP

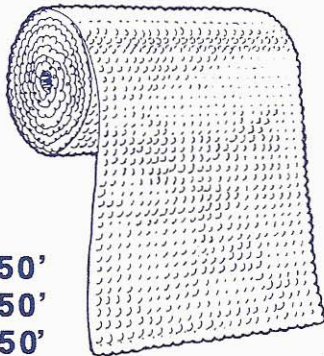

3/16"X750'
 5/8"X550'
 1/2"X250'

BUBBLE PACK*
FOAM WRAP*
FOAM POUCHES*
KIMPAK
KRAFT PAPER
NEWSPRINT
PACKING PEANUTS*
PROTECTIVE CORNERS
PROTECTIVE EDGES
TISSUE PAPER
VCI PAPER

* (ANTI-STATIC OR CLEAR)

PACKING PEANUTS

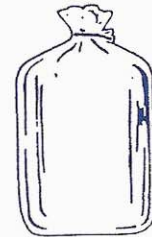

DISPENSERS

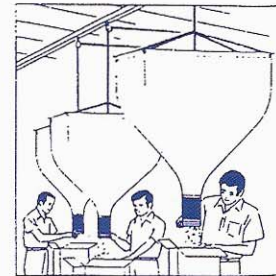

15 CU'
 30 CU'
 45 CU'
 60 CU'
 75 CU'
 90 CU'

PLASTIC BAGS

BUBBLE-OUT BAGS*
POLYBAGS*
POLYBAGS ON A ROLL*
POLY BAG SEALERS
STATIC-SHIELD BAGS
ZIPLOCK*
ZIPLOCK WHITE LABEL

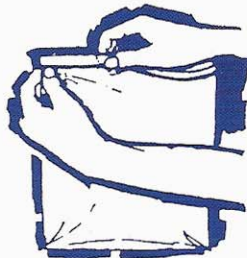

* (ANTI-STATIC OR CLEAR)

MAILER BAGS

BUBBLE*
FOAM*
PADDED
REINFORCED

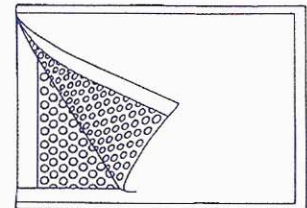

* (ANTI-STATIC OR CLEAR)

OTHER PRODUCTS AND SIZES AVAILABLE • CALL (630) 766-5400
www.CogsEnterprises.com

PACKAGING SUPPLIES

STRETCH WRAP

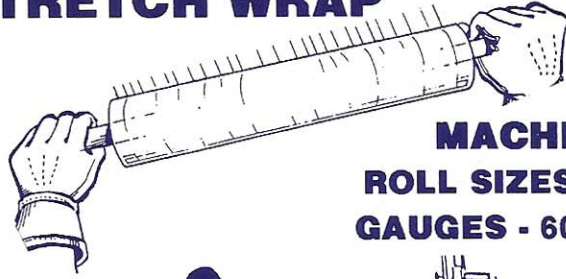

MACHINE WRAP
ROLL SIZES - 20" 30" 50" 60"
GAUGES - 60G 70G 80G 90G



HAND STRETCH WRAP

(CLEAR OR BLACK)

ROLL SIZES - 3" 5" 10" 12" 15" 18" 20"
GAUGES - LIGHT HEAVY & EXTRA HEAVY DUTY

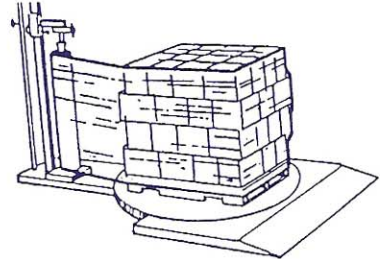

GOODWRAPPER IDENTI-WRAP AVAILABLE UPON REQUEST

STRAPPING

BUCKLES
CRIMPER
EDGE PROTECTORS
PLASTIC STRAPPING
METAL STRAPPING
MOBILE CART
SEALS
TENSIONERS



PACKING LIST ENVELOPES

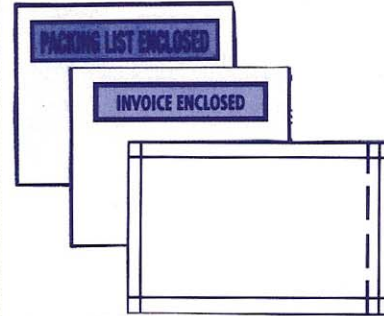

4 1/2 X 5 1/2
4 1/2 X 6
4 X 8
4 1/2 X 9
5 1/2 X 10
7 X 5 1/2

TAPES

CARTON SEALING (CLEAR/TAN)
CUSTOM
DISPENSERS
DOUBLE-SIDED
DUCT
ELECTRICAL
FILAMENT

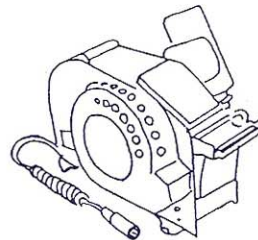

LABEL PROTECTION
MASKING
POLY STRAPPING
POUCH
PRINTED
REINFORCED GUM
TRANSFER

POLYETHYLENE SHEETING

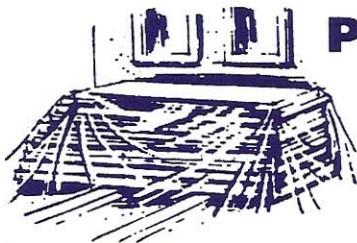

MATERIAL PROTECTION



TARPAULINS



EQUIPMENT COVERS

OTHER PRODUCTS AND SIZES AVAILABLE • CALL (630) 766-5400
www.CogsEnterprises.com

LIGHTING PRODUCTS

FLUORESCENT BULBS

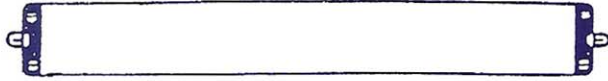

COOL WHITE
DAYLIGHT
NATURAL LIGHT

SHATTER PROOF
U - SHAPE TUBES
WARM WHITE

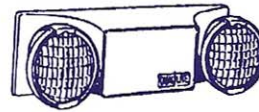

ENERGYSAVERS
HIGH OUTPUT
VERY HIGH OUTPUT

BALLASTS

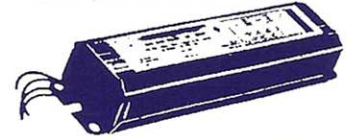

ENERGY SAVERS
HIGH OUTPUT
VERY HIGH OUTPUT

HIGH PRESSURE SODIUM

LU 50
LU 70
LU 150
LU 250
LU 400
LU 1000



HALOGEN QUARTZ



300 WATT 500 WATT 1500 WATT

MERCURY VAPOR

H38JA 100 DX	H37KC 200 DX
H38MP 100 DX	H33GL 400 DX
H37KC 175 DX	H36GW 1000 DX

METAL HALIDE BULBS

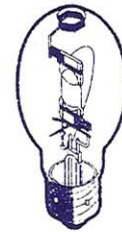

M 175 U
M 250 U
M 400 U
M 1000 U

COMPACT LAMPS

QUAD 9
QUAD 13
QUAD 22
QUAD 28

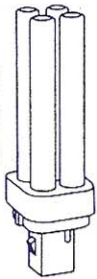

PL 5
PL 7
PL 9
PL 13



SPIRALS



EXIT SIGN LAMPS

T6
T6 1/2
T8
T10



HALOGEN LAMPS



INCANDESCENTS

CLEAR/FROSTED
25-100W



SPOT/FLOODS

PAR 38
75 WATTS
150 WATTS
ECON - O - PAR

HALOGEN QUARTZ

HP SODIUM
METAL HALIDE

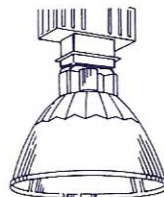
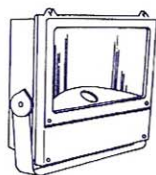

HIGH BAY

INDUSTRIAL SHIELDED

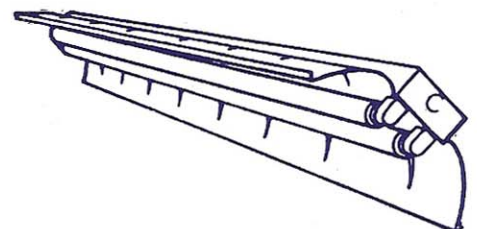

OTHER PRODUCTS AND SIZES AVAILABLE • CALL (630) 766-5400
www.CogsEnterprises.com

JANITORIAL

C-FOLD
MULTI-FOLD
NAPKINS
SINGLE-FOLD

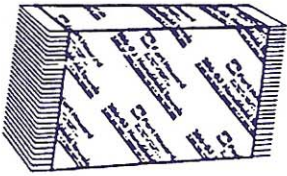

HAND TOWELS



PERFORATED ROLL



FACIAL TISSUE

HARD ROLL TOWELS

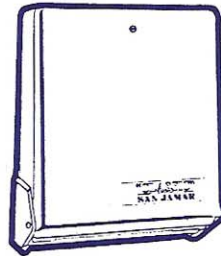
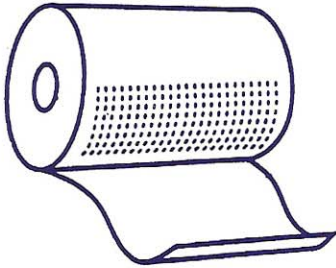

WORKSHOP TOWELS



HAND TOWEL DISPENSERS

TOILETRIES

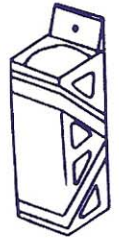
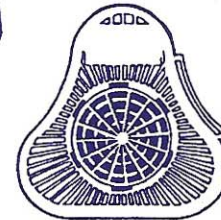

AIR FRESHENERS
HANGING BOWL BLOCKS
LATEX/NITRILE/VINYL GLOVES
TOILET BOWL CLEANER
TOILET BOWL BRUSHES
BOWL BLOCKS & SCREENS
WALL BLOCKS

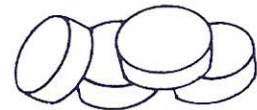

FEMININE NAPKINS
SEAT PROTECTION
TAMPONS

BAR SOAPS
LIQUID HAND SOAP
POWDERED HAND SOAP

TOILET TISSUE
JUMBO TISSUE
DISPENSERS

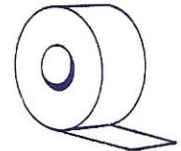
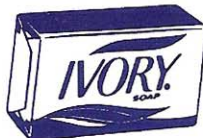

OTHER PRODUCTS AND SIZES AVAILABLE • CALL (630) 766-5400
www.CogsEnterprises.com

JANITORIAL

BROOMS

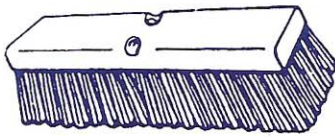

ANGLE
BENCH
CORN
DUST
LOBBY
PUSH
WISK



BROOM
BROOM
BROOM
PAN
BROOM
BROOM
BROOM

FLOOR CARE



SWEEPING
COMPOUND



SQUEEGEES



MOP HANDLES SCREW TYPE QUICK RELEASE

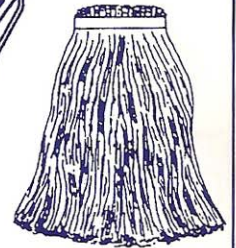
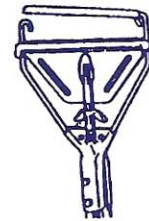

MOP HEADS COTTON/RAYON

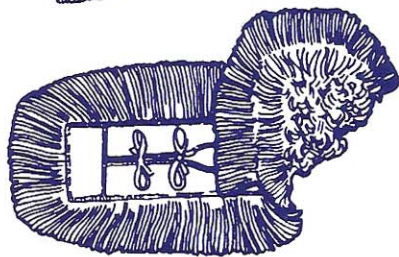

DUST MOPS

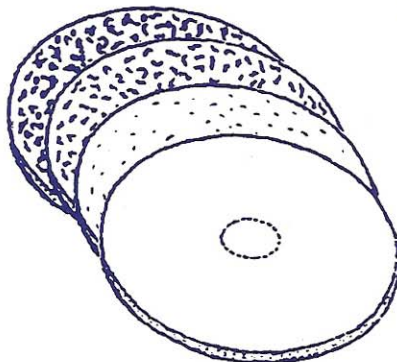

PADS

SPONGES

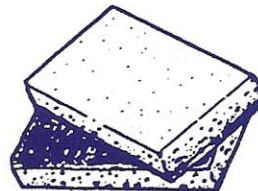

BUCKET / WRINGER

CHEMICALS

BLEACH
CLEANERS
DEGREASERS
DISINFECTANT/SANITIZER
DRAIN DEODORIZER
DRAIN OPENERS
FLOOR FINISHERS
FLOOR SEALERS
FLOOR STRIPPERS
FLOOR WAXES
GLASS CLEANERS
GRAFFITI REMOVERS
ICE MELT
INK REMOVERS
MULTI-PURPOSE CLEANERS
POLISHES
SWEEPING COMPOUND

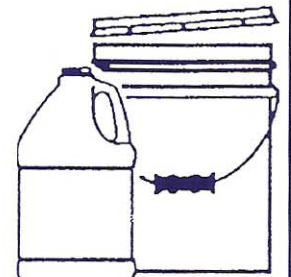

OTHER PRODUCTS AND SIZES AVAILABLE • CALL (630) 766-5400

www.CogsEnterprises.com

JANITORIAL

TRASH RECEPTACLES

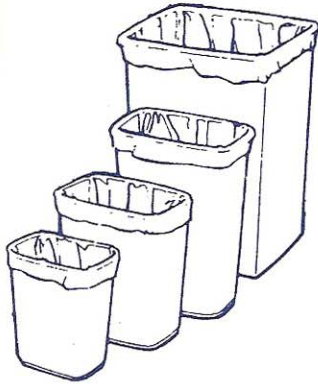

CAN LINERS

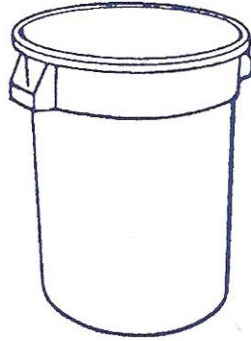
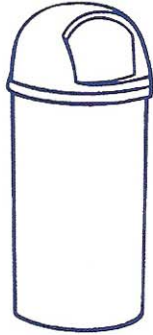

CUPS

4.5 OZ
5 OZ
6 OZ
8 OZ
12 OZ

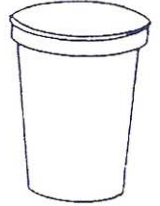

16 OZ
24 OZ
32 OZ

SPRAY BOTTLES

SAFETY EQUIPMENT

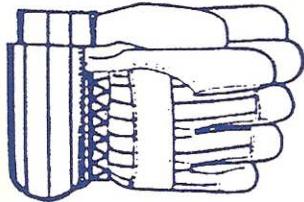

BACK BRACE SUPPORT
EMERGENCY WASH STATIONS
EYE PROTECTION
FIRST AID KITS
FLOOR MATS
GLOVES

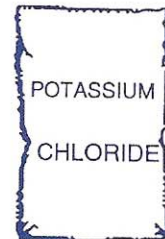

HAZARDOUS MATERIAL/SPILL CONTROL
HEARING PROTECTION
OIL DRY
OIL SOCKS
LABELS
PLACARDS
PROTECTIVE CLOTHING
RESPIRATORY PROTECTION
ROCK SALT
SAFETY CANS
SAFETY STORAGE

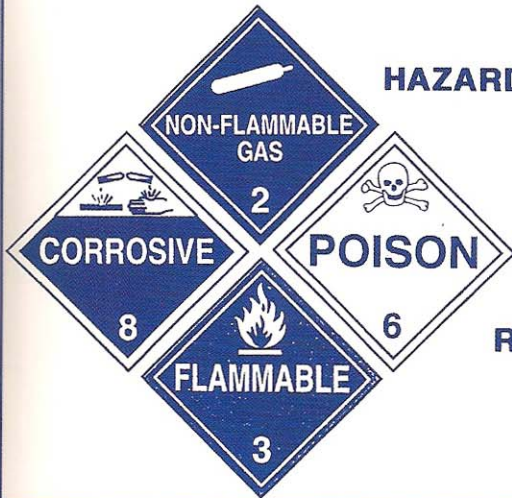

ODDS & ENDS

CARTON MARKERS
COMPUTER PAPER
COPY PAPER
DOCK SUPPLIES
FAX PAPER
GLUE GUNS
GLUE STICKS
NYLON CABLE TIES

PAILS/BUCKETS
RAZOR KNIVES
SCRAPERS
SHIPPING LABELS
SHOVELS
STAPLES
TRUCK SEALS
WEIGHT SCALES

DRUM ACCESSORIES

CRADLES
DISPENSERS
DOLLIES
EMPTY DRUMS
FIBER DRUMS
LINERS
STORAGE RACKS
SALVAGE DRUMS



OTHER PRODUCTS AND SIZES AVAILABLE • CALL (630) 766-5400
www.CogsEnterprises.com

COGS

ENTERPRISES, INC.

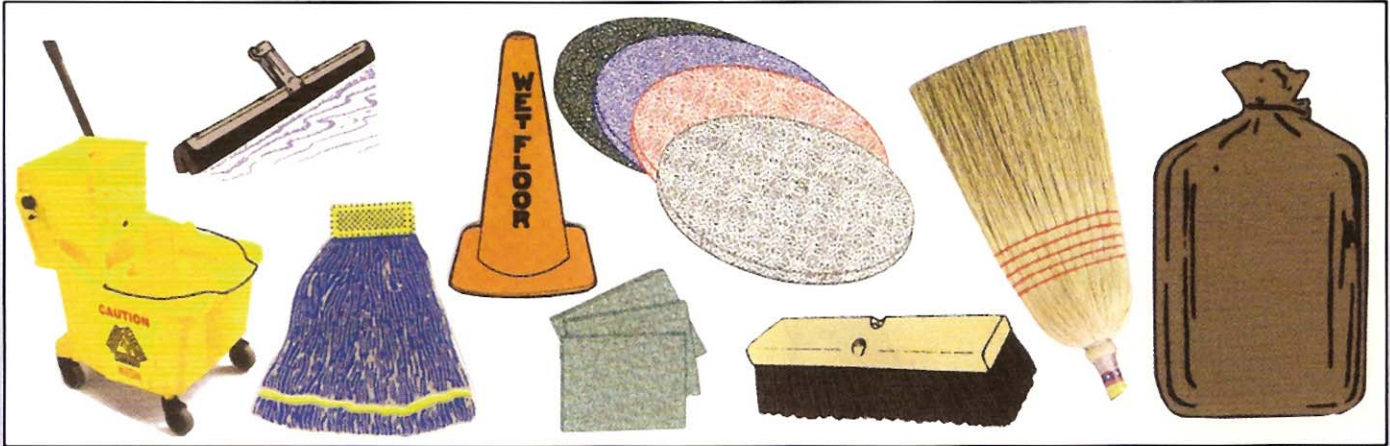

132 W. DEVON AVE. BENSENVILLE, IL. 60106

CALL (630) 766-5400 OR FAX (630) 766-5593

www.CogsEnterprises.com